

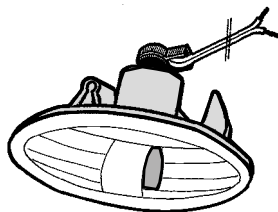

P 20542

FLC: 206 (1998 → 2006)
407 (2004 →)
107 - 1007 (2005 →)
307 (2001 → 2008)



P 20543

FLC: 206 (1998 → 2006)
407 (2004 →)
107 - 1007 (2005 →)
307 (2001 → 2008)

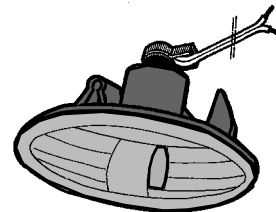

Versione speciale fumè
Smoked special version

P 353 /D /S

GOL: BOXER (2006 →)

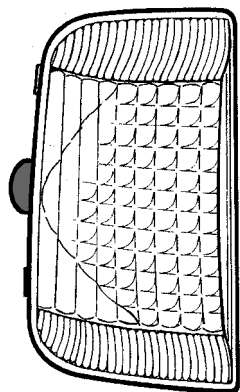

P 355 /D /S

GOL: BOXER (2006 →)

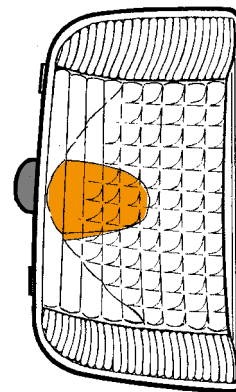



P 9494

GOL: 106 (1991 → 96)
306 (1993 → 97)
605 (1990 →)



P 1027 /D
/S

GOA: 405

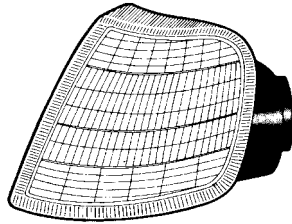

P 2753 /D
/S

GOA: 305 (→ 1993)

MTA: FRANKANI

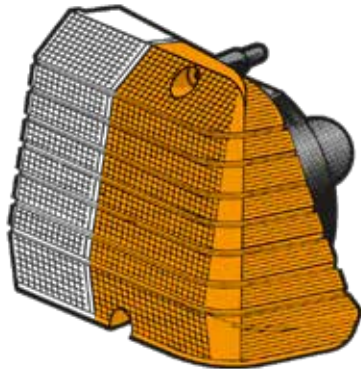

P 2737

Bordo verniciato argento
Silver painted rim

PFA: 404



P 2736

Bordo metallizzato
Chromium plated rim

P 2713 /D
/S

PFA: 104

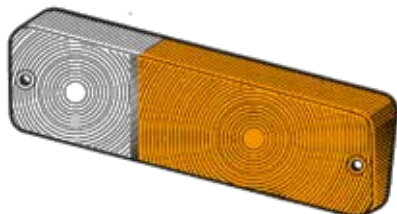

P 2723 /D
/S

Bordo verniciato argento
Silver painted rim

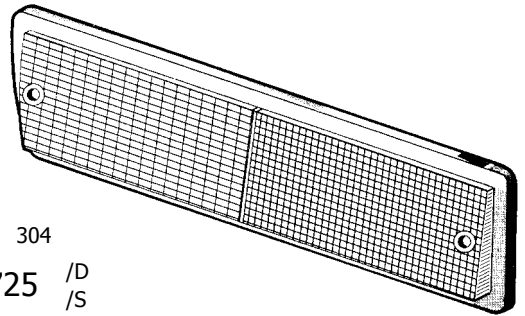

PFA: 304

P 2725 /D
/S

Bordo metallizzato
Chromium plated rim

P 2724 /D
/S

Bordo verniciato argento
Silver painted rim

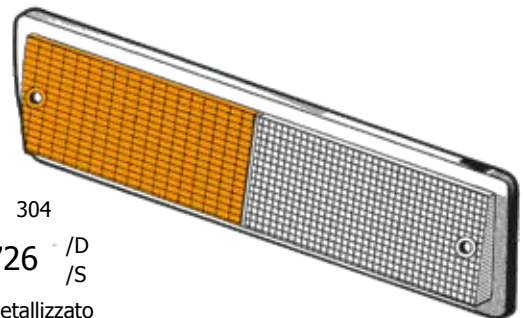

PFA: 304

P 2726 /D
/S

Bordo metallizzato
Chromium plated rim

P 2740 /D
/S

Bordo verniciato argento
Silver painted rim

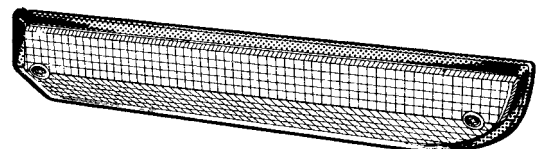

PFA: 504
(1970 → 82)

P 2742 /D
/S

Bordo metallizzato
Chromium plated rim

P 2741 /D
/S

Bordo verniciato argento
Silver painted rim

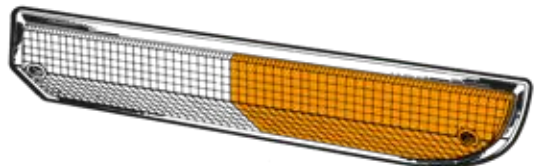

PFA: 504
(1970 → 82)

P 2743 /D
/S

Bordo metallizzato
Chromium plated rim



P 2719 /D
/S

Bordo verniciato argento
Silver painted rim

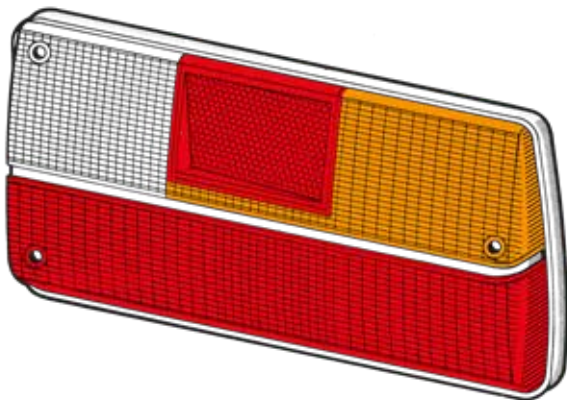

PPF: 304
MTA: SEIMA

P 2718 /D
/S

Bordo metallizzato
Chromium plated rim

P 2770 /D
/S

Bordo verniciato argento
Silver painted rim

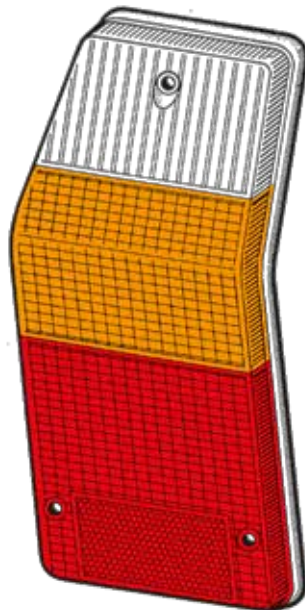

PPF: 504 BREK

P 2769 /D
/S

Bordo metallizzato
Chromium plated rim

P 2705

PPF: J-7 FURGONE

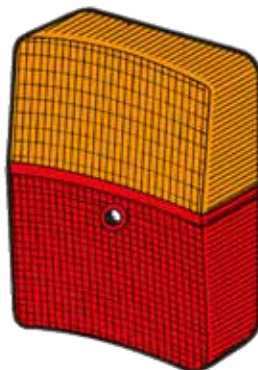

P 2759 /D
/S

Bordo verniciato argento
Silver painted rim

PPF: 504
(1970 → 82)

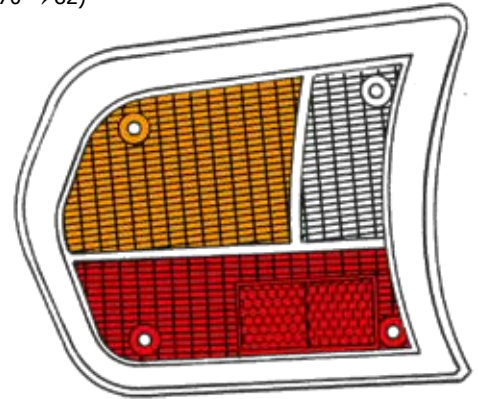

P 2758 /D
/S

Bordo metallizzato
Chromium plated rim

P 2789 /D
/S

Bordo verniciato argento
Silver painted rim

PPF: 104 (→ 1976)
CITROEN LN

MTA: SEIMA

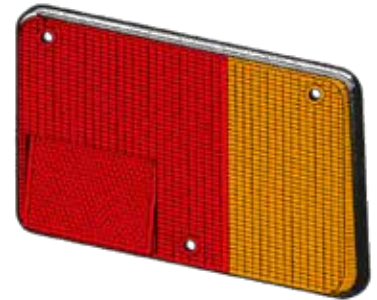

P 2788 /D
/S

Bordo metallizzato
Chromium plated rim

P 2791 /D
/S

Bordo verniciato argento
Silver painted rim

PPF: 104 (1976 →)

MTA: FRANKANI

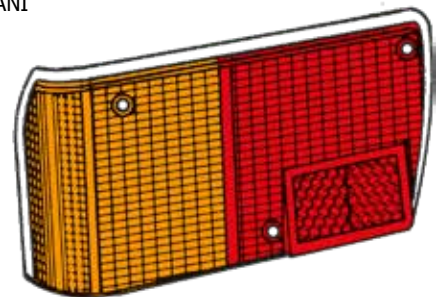

P 2792 /D
/S

Bordo verniciato arancio
Orange painted rim



P 2748 ^{/D}/_S

PFP: 205 (1985 → 90)

MTA: SEIMA

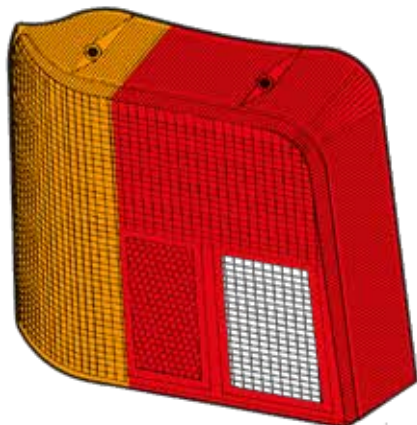

P 2747 ^{/D}/_S

PFP: 205 (1985 → 90)

MTA: FRANKANI



P 2746 ^{/D}/_S

PFP: 205 (1985 → 90)

Copribuco paraurti

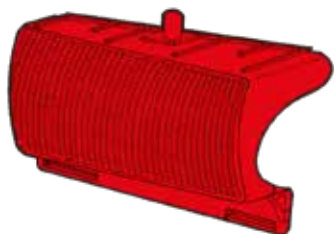

P 10455 ^{/D}/_S

PFA: POLSKY 125 II Serie

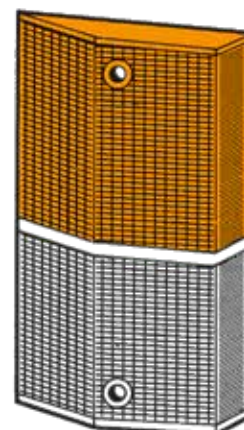

P 10457 ^{/D}/_S

PFA: POLSKY 125 I Serie



P 10456 ^{/D}/_S

PFA: POLSKY 125 I Serie

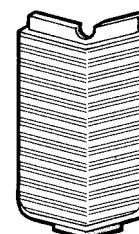



CONDIZIONI GENERALI DI VENDITA

Questo catalogo contiene tutta la produzione P/V, con esclusione dei proiettori lampeggianti che sono presentati con altro apposito catalogo, elencata in ordine alfabetico della denominazione delle marche delle vetture alle quali vanno applicati i prodotti.

Alcuni articoli sono stati inclusi nel presente catalogo solo nella versione più richiesta o più consigliabile. Tuttavia è possibile che molti articoli, elencati nei precedenti cataloghi, siano disponibili a magazzino.

Tutti gli articoli elencati nel presente catalogo, pur essendo perfettamente intercambiabili agli originali, non sono originali. Tutti i riferimenti riportati in questo catalogo, sia di nomi di marche di vetture che di altri fabbricanti di ricambi, non attestano l'originalità, ma l'intercambiabilità dei prodotti. I prodotti riportati nel presente catalogo sono parti di ricambio di qualità equivalente, in conformità al Regolamento CE 1400/2002. I riferimenti al costruttore OEM sono offerti unicamente al fine di identificare l'utilizzo del ricambio.

La merce viaggia a spese, rischio e pericolo dell'acquirente, anche se resa franco destino.

Gli eventuali reclami per consegne difettose o incomplete devono essere fatti immediatamente all'atto del ricevimento della merce ed ogni eventuale resa di materiali dovrà essere da noi preventivamente autorizzata.

Gli eventuali difetti della merce, riconosciuti dal fornitore, obbligano lo stesso alla sola sostituzione del materiale alle medesime condizioni del contratto, con esclusione di ogni risarcimento per danni od altro.

Per qualsiasi controversia è in ogni caso competente il solo Foro di Milano.

This catalogue includes the entire P/V productions, except flashing lights which are shown in another catalogue, listed in alphabetical order following the domination of the car manufacturers.

Certain parts listed in the former catalogues and not contained in the present one may still be ordered, in any colour requested.

All items illustrated in this catalogue, although perfectly interchangeable with the original ones, are not original. All references made in this catalogue to individual brand names or other parts manufacturers, following the domination of the car manufacturers, do not claim to be original products, but are interchangeable products. Items listed in this catalogue are matching quality spare partes, in line with Regulation EC 1400/2002. References to OE manufacturers are provided solely for the purpose of identifying spare parts fitting.

Goods travel at customer's risk even when delivery term is free destination.

Any eventual claim on quantities or defects must be declared immediately on the receipt of the goods. Returned goods are accepted only if authorized in advance by us.

Should any lack be found on the goods delivered and acknowledged by the supplier, same is only bound to replace the goods in the same contractual terms, without any further refund of whatever additional charge for damns or other.

Should any dispute arise, the Court of Milano shall have the sole jurisdiction.

LEGENDA ABBREVIAZIONI

LIST OF ABBREVIATIONS

PFR:

Plastica per fanale retromarcia adattabile su
Reversing lamp lens adaptable for

PFP:

Plastica per fanale posteriore adattabile su
Rear lamp lens adaptable for

PFA:

Plastica per fanale anteriore adattabile su
Front lamp lens adaptable for

PFL:

Plastica per fanale laterale adattabile su
Side lamp lens adaptable for

GOP:

Gruppo ottico posteriore, senza portalampada, adattabile su
Rear optical unit, without bulbholder, adaptable for

GOA:

Gruppo ottico anteriore, senza portalampada, adattabile su
Front lamp optical unit, without bulbholder, adaptable for

GOL:

Gruppo ottico laterale, senza portalampada, adattabile su
Side lamp optical unit, without bulbholder, adaptable for

FPC:

Fanale posteriore adattabile su
Rear lamp adaptable for

FAC:

Fanale anteriore adattabile su
Front lamp adaptable for

FLC:

Fanale laterale adattabile su
Side lamp adaptable for

CAT:

Catarifrangente
Reflex-reflector

GFA:

Guarnizione fanale anteriore adattabile su
Front lamp gasket adaptable for

GFP:

Guarnizione fanale posteriore adattabile su
Rear lamp gasket adaptable for

GFL:

Guarnizione fanale laterale adattabile su
Side lamp gasket adaptable for

CFP:

Corpo fanale posteriore adattabile su
Rear lamp body adaptable for

CFA:

Corpo fanale anteriore adattabile su
Front lamp body adaptable for

CFL:

Corpo fanale laterale adattabile su
Side lamp body adaptable for

MTA:

Modello tipo adattabile su fanale marca
Model suitable for individual type fitting